

JVC

VIDEO CASSETTE RECORDER

HR-A5U

INSTRUCTIONS

VHS
Hi-Fi
SQPB

LPT0588-001A
COPYRIGHT © 2001 VICTOR COMPANY OF JAPAN, LTD.





Printed in China
0301 IYV*ID*BJ

Dear Customer,

Thank you for purchasing the JVC VHS video cassette recorder. Before use, please read the safety information and precautions to ensure safe use of your new VCR.

CAUTIONS

| | | |
|---|---|---|
|  | CAUTION RISK OF ELECTRIC SHOCK DO NOT OPEN |  |
| CAUTION: TO REDUCE THE RISK OF ELECTRIC SHOCK, DO NOT REMOVE COVER (OR BACK). NO USER-SERVICEABLE PARTS INSIDE. REFER SERVICING TO QUALIFIED SERVICE PERSONNEL. | | |



The lightning flash with arrowhead symbol, within an equilateral triangle, is intended to alert the user to the presence of uninsulated "dangerous voltage" within the product's enclosure that may be of sufficient magnitude to constitute a risk of electric shock to persons.



The exclamation point within an equilateral triangle is intended to alert the user to the presence of important operating and maintenance (servicing) instructions in the literature accompanying the appliance.

WARNING:

TO PREVENT FIRE OR SHOCK HAZARD, DO NOT EXPOSE THIS UNIT TO RAIN OR MOISTURE.

CAUTION:

This video cassette recorder should be used with AC 120V~, 60Hz only.

To prevent electric shocks and fire hazards, DO NOT use any other power source.

CAUTION:

TO PREVENT ELECTRIC SHOCK, MATCH WIDE BLADE OF PLUG TO WIDE SLOT, FULLY INSERT.

ATTENTION:

POUR ÉVITER LES CHOCS ÉLECTRIQUES, INTRODUIRE LA LAME LA PLUS LARGE DE LA FICHE DANS LA BORNE CORRESPONDANTE DE LA PRISE ET POUSSER JUSQU'AU FOND.

Note to CATV system installer:

This reminder is provided to call the CATV system installer's attention to Article 820-40 of the NEC that provides guidelines for proper grounding and, in particular, specifies that the cable ground shall be connected to the grounding system of the building, as close to the point of cable entry as practical.

CAUTION:

Changes or modifications not approved by JVC could void user's authority to operate the equipment.

Declaration of Conformity

Model Number: HR-A5U
Trade Name: JVC
Responsible Party: JVC Americas Corp.
Address: 1700 Valley Road Wayne, N.J. 07470
Telephone Number: 973-315-5000

This device complies with Part 15 of FCC Rules.

Operation is subject to the following two conditions:

(1) This device may not cause harmful interference, and (2) this device must accept any interference received, including interference that may cause undesired operation.

Failure to heed the following precautions may result in damage to the VCR, Remote or video cassette.

1. **DO NOT** place the VCR ...
 - ... in an environment prone to extreme temperatures or humidity.
 - ... in direct sunlight.
 - ... in a dusty environment.
 - ... in an environment where strong magnetic fields are generated.
 - ... on a surface that is unstable or subject to vibration.
2. **DO NOT** block the VCR's ventilation openings.
3. **DO NOT** place heavy objects on the VCR or on the Remote.
4. **DO NOT** place anything which might spill on the top of the VCR or on the Remote.
5. **AVOID** violent shocks to the VCR during transport..

For Customer Use:

Enter below the Model No. and Serial No. which are located on the rear of cabinet. Retain this information for future reference.

Model No. _____

Serial No. _____



- Cassettes marked "VHS" (or "S-VHS") can be used with this video cassette recorder. However, S-VHS recording is not possible with this model.
- This model is equipped with SQPB (S-VHS QUASI PLAYBACK) that makes it possible to play back S-VHS recordings with regular VHS resolution.
- HQ VHS is compatible with existing VHS equipment.
- As an ENERGY STAR® Partner, JVC has determined that this product or product model meets the ENERGY STAR® guidelines for energy efficiency.

IMPORTANT PRODUCT SAFETY INSTRUCTIONS

Electrical energy can perform many useful functions. But improper use can result in potential electrical shock or fire hazards. This product has been engineered and manufactured to assure your personal safety. In order not to defeat the built-in safeguards, observe the following basic rules for its installation, use and servicing.

ATTENTION:

Follow and obey all warnings and instructions marked on your product and its operating instructions. For your safety, please read all the safety and operating instructions before you operate this product and keep this booklet for future reference.

INSTALLATION

1. Grounding or Polarization

(A) Your product may be equipped with a polarized alternating-current line plug (a plug having one blade wider than the other). This plug will fit into the power outlet only one way. This is a safety feature.

If you are unable to insert the plug fully into the outlet, try reversing the plug. If the plug should still fail to fit, contact your electrician to replace your obsolete outlet. Do not defeat the safety purpose of the polarized plug.

(B) Your product may be equipped with a 3-wire grounding-type plug, a plug having a third (grounding) pin. This plug will only fit into a grounding-type power outlet. This is a safety feature. If you are unable to insert the plug into the outlet, contact your electrician to replace your obsolete outlet. Do not defeat the safety purpose of the grounding-type plug.

2. Power Sources

Operate your product only from the type of power source indicated on the marking label. If you are not sure of the type of power supply to your home, consult your product dealer or local power company. If your product is intended to operate from battery power, or other sources, refer to the operating instructions.

3. Overloading

Do not overload wall outlets, extension cords, or integral convenience receptacles as this can result in a risk of fire or electric shock.

4. Power Cord Protection

Power supply cords should be routed so that they are not likely to be walked on or pinched by items placed upon or against them, paying particular attention to cords at plugs, convenience receptacles, and the point where they exit from the product.

5. Ventilation

Slots and openings in the cabinet are provided for ventilation. To ensure reliable operation of the product and to protect it from overheating, these openings must not be blocked or covered.

- Do not block the openings by placing the product on a bed, sofa, rug or other similar surface.
- Do not place the product in a built-in installation such as a bookcase or rack unless proper ventilation is provided or the manufacturer's instructions have been adhered to.

6. Wall or Ceiling Mounting

The product should be mounted to a wall or ceiling only as recommended by the manufacturer.

ANTENNA INSTALLATION INSTRUCTIONS

1. Outdoor Antenna Grounding

If an outside antenna or cable system is connected to the product, be sure the antenna or cable system is grounded so as to provide some protection against voltage surges and built-up static charges. Article 810 of the National Electrical Code, ANSI/NFPA 70, provides information with regard to proper grounding of the mast and supporting structure, grounding of the lead-in wire to an antenna discharge unit, size of grounding connectors, location of antenna discharge unit, connection to grounding electrodes, and requirements for the grounding electrode.

2. Lightning

For added protection for this product during a lightning storm, or when it is left unattended and unused for long periods of time, unplug it from the wall outlet and disconnect the antenna or cable system. This will prevent damage to the product due to lightning and power-line surges.

3. Power Lines

An outside antenna system should not be located in the vicinity of overhead power lines or other electric light or power circuits, or where it can fall into such power lines or circuits. When installing an outside antenna system, extreme care should be taken to keep from touching such power lines or circuits as contact with them might be fatal.

EXAMPLE OF ANTENNA GROUNDING AS PER NATIONAL ELECTRICAL CODE, ANSI/NFPA 70

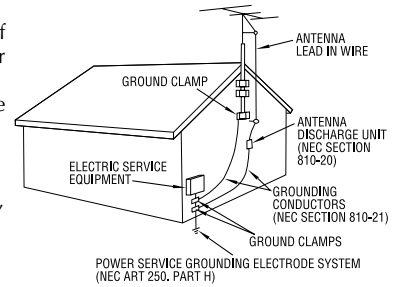

NEC - NATIONAL ELECTRICAL CODE

USE

1. Accessories

To avoid personal injury:

- Do not place this product on an unstable cart, stand, tripod, bracket, or table. It may fall, causing serious injury to a child or adult, and serious damage to the product.
- Use only with a cart, stand, tripod, bracket, or table recommended by the manufacturer or sold with the product.
- Use a mounting accessory recommended by the manufacturer and follow the manufacturer's instructions for any mounting of the product.
- Do not try to roll a cart with small casters across thresholds or deep-pile carpets.

2. Product and Cart Combination

A product and cart combination should be moved with care. Quick stops, excessive force, and uneven surfaces may cause the product and cart combination to overturn.

3. Water and Moisture

Do not use this product near water—for example, near a bath tub, wash bowl, kitchen sink or laundry tub, in a wet basement, or near a swimming pool and the like.

4. Object and Liquid Entry

Never push objects of any kind into this product through openings as they may touch dangerous voltage points or short-out parts that could result in a fire or electric shock. Never spill liquid of any kind on the product.

5. Attachments

Do not use attachments not recommended by the manufacturer of this product as they may cause hazards.

6. Cleaning

Unplug this product from the wall outlet before cleaning. Do not use liquid cleaners or aerosol cleaners. Use a damp cloth for cleaning.

7. Heat

The product should be situated away from heat sources such as radiators, heat registers, stoves, or other products (including amplifiers) that produce heat.

PORTABLE CART WARNING
(Symbol provided by RETAC)



SERVICING

1. Servicing

If your product is not operating correctly or exhibits a marked change in performance and you are unable to restore normal operation by following the detailed procedure in its operating instructions, do not attempt to service it yourself as opening or removing covers may expose you to dangerous voltage or other hazards. Refer all servicing to qualified service personnel.

2. Damage Requiring Service

Unplug this product from the wall outlet and refer servicing to qualified service personnel under the following conditions:

- When the power supply cord or plug is damaged.
- If liquid has been spilled, or objects have fallen into the product.
- If the product has been exposed to rain or water.
- If the product does not operate normally by following the operating instructions. Adjust only those controls that are covered by the operating instructions as an improper adjustment of other controls may result in damage and will often require extensive work by a qualified technician to restore the product to its normal operation.
- If the product has been dropped or damaged in any way.
- When the product exhibits a distinct change in performance—this indicates a need for service.

3. Replacement Parts

When replacement parts are required, be sure the service technician has used replacement parts specified by the manufacturer or which have the same characteristics as the original part. Unauthorized substitutions may result in fire, electric shock or other hazards.

4. Safety Check

Upon completion of any service or repairs to this product, ask the service technician to perform safety checks to determine that the product is in safe operating condition.

How to use the Remote

Before use, insert two AA size batteries into the Remote with the polarity (\oplus and \ominus) matched correctly as indicated on the battery compartment or on the lid.

The Remote can operate most of your VCR's functions, as well as basic functions of TV sets, cable boxes and DBS receivers.

- Point the Remote toward the remote sensor on the target component.
- The maximum operating distance of the remote control is about 8 m.

NOTE:

If the Remote does not work properly, remove its batteries, wait for a few seconds, replace the batteries and then try again.

Video heads cleaning

Use a dry cleaning cassette — TCL-2UX — when:

- Rough, poor picture appears while a tape is played back.
- The picture is unclear or no picture appears.
- "USE CLEANING CASSETTE" appears on the screen (only with "SUPERIMPOSE" set to "ON").

Buttons, Connectors and Indicators

Front Panel

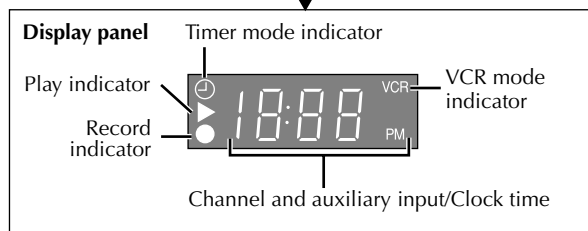
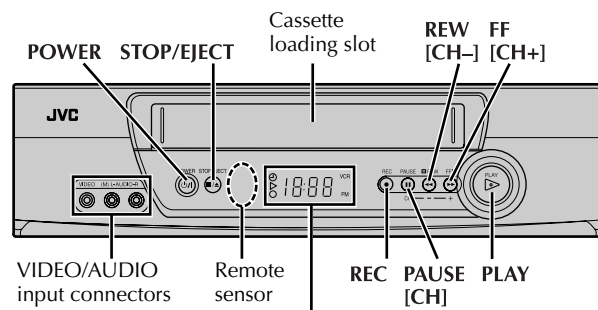

Rear Panel

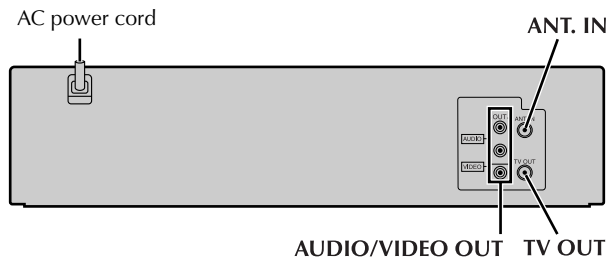

Remote

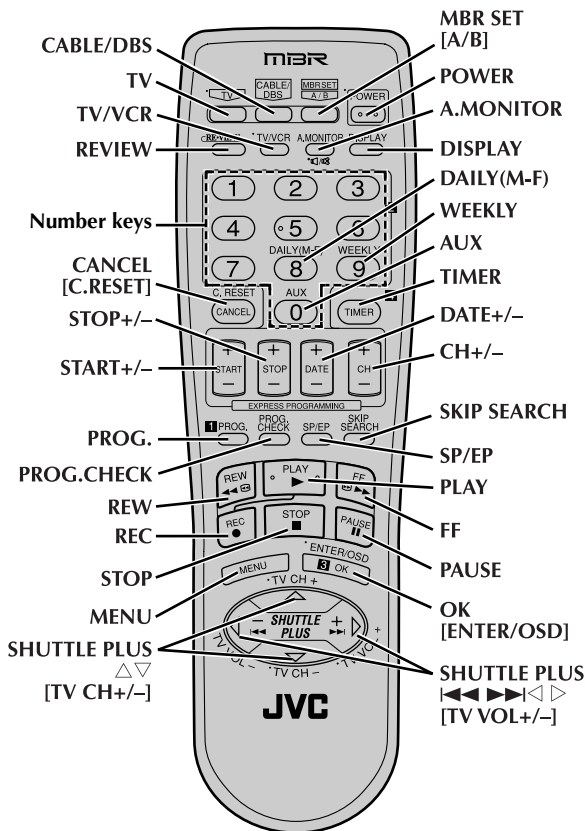

Connections and Plug&Play Setting

1 Check contents

Make sure the package contains all of the accessories listed in "Specifications".

2 Situate VCR

Place the VCR on a stable, horizontal surface.

3 Connect VCR to TV

RF Connection

- 1 Disconnect the TV antenna from the TV.
- 2 Connect the TV antenna cable to the ANT. IN terminal on the rear of the VCR.
- 3 Connect the supplied RF cable between the TV OUT terminal on the rear of the VCR and the TV's antenna input terminal.

AV Connection

(improves picture quality during tape playback.)

If your TV is equipped with audio/video input connectors

- 1 Connect the antenna, VCR and TV as shown in the illustration.
 - 2 Connect an audio/video cable between the AUDIO/VIDEO OUT connectors on the rear of the VCR and the audio/video input connectors on the TV.
- Even if you are using audio/video cables to connect your VCR to your TV, you must also connect it using the RF cable. This will ensure that you can record one show while watching another.

On-screen display

If you press **OSD** on the Remote when "SUPERIMPOSE" is set to "ON", you can see the current VCR status on the TV screen. Press **OSD** again to exit on-screen display.

The indications are not recorded even if the VCR is in the recording mode.

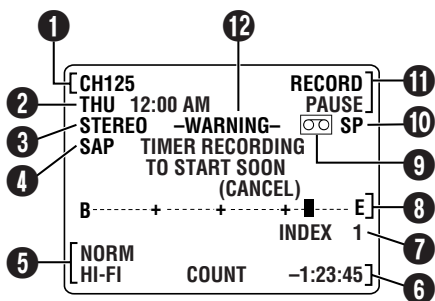

- 1 Channel and auxiliary input
- 2 Day and clock time
- 3 STEREO program indication
- 4 SAP indication
- 5 Audio monitor indications
- 6 Time counter
- 7 Index number
- 8 Tape position
- 9 Cassette mark
- 10 Tape speed
- 11 VCR operation mode
- 12 Timer warning display

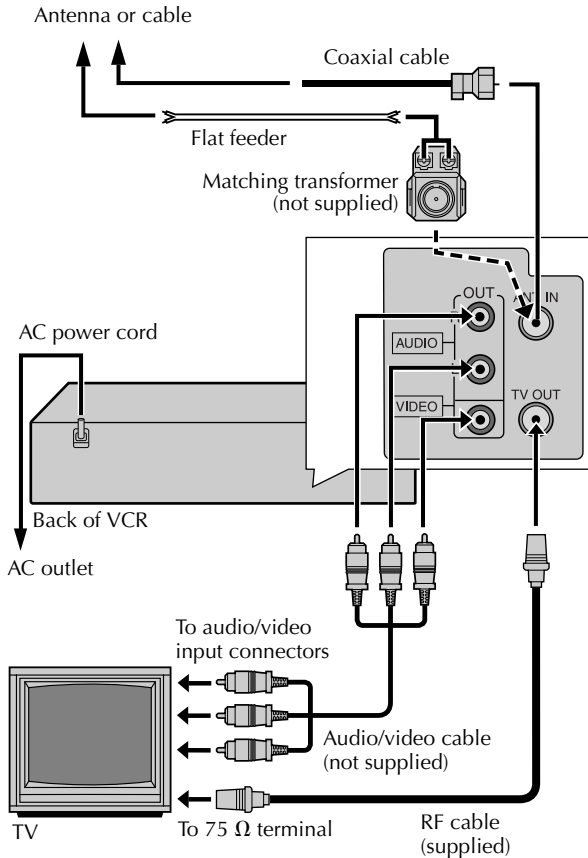

4 Perform Plug&Play setup

Plug the AC power cord into an AC outlet. Do not turn on the VCR. The clock and tuner channels will be set automatically. The time and date can be set automatically by the clock setting data transmitted from one of the regular TV broadcast channels. We call this TV channel the "host channel" and it is a PBS channel in your area.

ATTENTION:

If you use a cable box, Plug&Play will not function; set the clock and tuner channels separately.



During Initial Auto Clock Set
"Aut" blinks.



During Auto Channel Set
The channel numbers are displayed as they are scanned and set.



Plug&Play Completed
The current time is displayed.

What to do if Plug&Play setting failed

- If an incorrect time is displayed on the display panel, perform the "Semiauto Clock Set" or "Manual Clock Set" procedure.
- If "--:--" appears on the display panel, ensure that the antenna cable is connected correctly. Then turn on and off the VCR; the Plug&Play setting will be automatically reactivated. If Plug&Play setting is not performed though the antenna cable is connected correctly, perform "Manual Clock Set" and "Auto Channel Set" or "Manual Channel Set".

5 Set VCR channel

The VCR channel is the channel on which you can watch the picture from the VCR on the TV when only using the RF connection. Press **POWER** to turn off the VCR, then press **STOP/EJECT** (■/▲) on the VCR for more than 5 seconds. "CH3" appears on the display panel. Press **CH+/-** on the Remote to select "CH3", "CH4" or "CH-"(OFF), then press **OK**.

- The VCR channel is preset to "CH3". Set to "CH4" if CH3 is used for broadcasting in your area.

6 Final preparation for use

Turn on the VCR and the TV, and select the VCR channel 3 or 4 (or AV mode) on the TV. You can now perform basic playback or basic recording.

Initial Settings

Language Setting

The default setting is "ENGLISH".

1 Access Main Menu screen, then Initial Set screen

Press **MENU** on the Remote. Press Δ/∇ to move the highlight bar (arrow) to "INITIAL SET", then press **OK** or \triangleright .

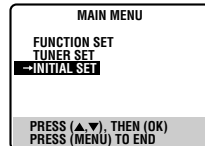

2 Select language

This VCR offers you the language choice to view menus and some messages — in English, Spanish or French. Press Δ/∇ to move the highlight bar (arrow) to "LANGUAGE" or \triangleright repeatedly until the desired language is selected.

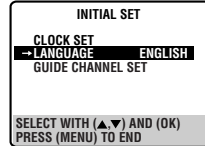

Press **MENU** to return to normal screen.

Clock Setting

Perform clock setting only if the clock has not been set correctly by the Plug&Play setting or if you use a cable box.

Preparations

1 Access Main Menu screen, then Initial Set screen

Press **MENU** on the Remote. Press Δ/∇ to move the highlight bar (arrow) to "INITIAL SET", then press **OK** or \triangleright .

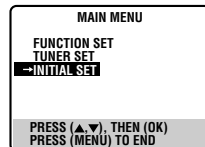

2 Access Clock Set screen

Press Δ/∇ to move the highlight bar (arrow) to "CLOCK SET", then press **OK** or \triangleright .



Setting clock semiautomatically — Semiauto Clock Set

You can change the host channel/D.S.T. (Daylight Saving Time)/time zone setting manually. First follow steps 1 to 2 in "Preparations" above, then go to the following steps.

NOTE:

The time set previously will be erased when "AUTO CLOCK", "HOST CH", "D.S.T." or "TIME ZONE" setting is changed.

– Initial Settings –

1 Set Auto Clock to ON

Press **OK** or **▷** on the Remote repeatedly to move the highlight bar to “AUTO CLOCK”, then press **△▽** so that “ON” is selected.

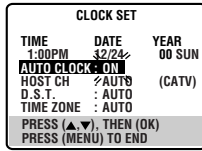

2 Select host channel

You can either select “AUTO” or enter a PBS channel number. Press **OK** or **▷** to move the highlight bar to “HOST CH”, then press **△▽** repeatedly until “AUTO” or the desired PBS channel number is selected.

3 Select D.S.T. mode

Press **OK** or **▷** to move the highlight bar to “D.S.T.”, then press **△▽** repeatedly until the desired setting is selected.

AUTO: Select if you want to adjust your VCR’s clock automatically by the incoming signal from the host channel. (Auto Daylight Saving Time enables automatic adjustment of the VCR’s clock at the start and end of Daylight Saving Time.) Be sure to select the correct time zone manually in step 4.

ON: Adjustment will be made by the built-in clock itself.

OFF: Select when Daylight Saving Time does not apply to you.

4 Select time zone

Press **OK** or **▷** to move the highlight bar to “TIME ZONE”, then press **△▽** repeatedly until “AUTO” or the desired time zone is selected. Each time you press the button, the time zone changes as follows:

↔ AUTO ↔ ATLANTIC ↔ EASTERN ↔ CENTRAL
 ↔ MOUNTAIN ↔ PACIFIC ↔ ALASKA ↔ HAWAII
 ↔ (back to the beginning)

5 Complete Semiauto Clock Set

Press **MENU** to return to normal screen. Turn off the VCR. “Aut” will appear on the display panel while the clock is being set. The current clock time will appear automatically when the clock setting is complete.

Setting clock manually — Manual Clock Set

First follow steps 1 to 2 in “Preparations” above, then go to the following steps.

1 Set time, date and year

Press **△▽** until the desired time appears, then press **OK** or **▷**. Set the date and year in the same way.

- Holding **△▽** changes the time in 30-minute intervals, or changes the date in 15-day intervals.

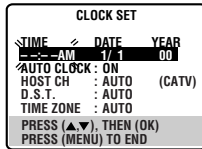

2 Select D.S.T. mode

Press **OK** or **▷** to move the highlight bar to “D.S.T.”, then press **△▽** to select the desired setting.

ON: Adjustment will be made by the built-in clock itself.

OFF: Select when Daylight Saving Time does not apply to you.

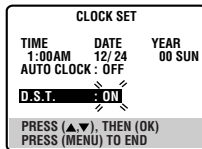

3 Start clock

Press **MENU** and normal screen appears.

To make corrections any time during the process

Press **OK** or **▷** repeatedly until the item you want to change blinks, then press **△▽**.

Tuner Setting

Setting channels automatically — Auto Channel Set

Perform Auto Channel Set only if channels have not been set correctly by the Plug&Play setting.

1 Access Main Menu screen, then Tuner Set screen

Press **MENU** on the Remote. Press **△▽** to move the highlight bar (arrow) to “TUNER SET”, then press **OK** or **▷**.

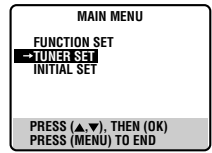

2 Perform Auto Channel Set

Press **△▽** to move the highlight bar (arrow) to “AUTO CHANNEL SET”, then press **OK** or **▷**. The VCR selects the correct band (TV or CATV) automatically during Auto Channel Set.

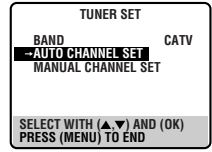

- When Auto Channel Set is complete, “SCAN COMPLETED” appears on screen.

- If the scan was unsuccessful, “SCAN COMPLETED—NO SIGNAL—” appears on screen. Check the connections and start again.

Press **MENU** to return to normal screen.

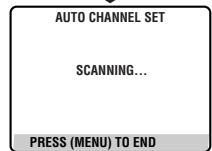

Setting channels manually — Manual Channel Set

You can add the channels you want or delete the channels you do not want manually.

1 Access Main Menu screen, then Tuner Set screen

Press **MENU** on the Remote. Press **△▽** to move the highlight bar (arrow) to “TUNER SET”, then press **OK** or **▷**.

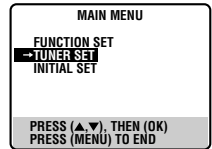

2 Access Manual Channel Set screen

Press **△▽** to move the highlight bar (arrow) to “MANUAL CHANNEL SET”, then press **OK** or **▷**.

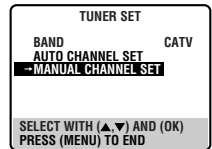

3 Add or skip desired channels

To add channels

- 1 Press the **Number keys** on the Remote to input a channel number you want to add.
- 2 Press **OK** or **▷** to set to “ADD”.
- 3 Repeat 1 to 2 to add other channels. Press **MENU** to return to normal screen.

To skip channels

- 1 Press **△▽** or the **Number keys** to select a channel number you want to skip.
- 2 Press **OK** or **▷** to set to “SKIP”.
- 3 Repeat 1 and 2 to skip other channels. Press **MENU** to return to normal screen.

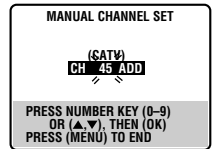

Playback

Basic Playback

1 Load a cassette

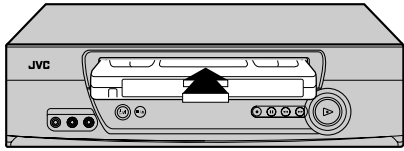

Make sure the window side is up, the rear label side is facing you and the arrow on the front of the cassette is pointing towards the VCR.

- Do not apply too much pressure when inserting.
- The VCR turns on, and the counter on the on-screen display is reset, automatically.
- If the cassette's record safety tab has been removed, playback begins automatically.

2 Start playback

Press **PLAY** (▶).

During playback

Stop playback

Press **STOP** (■) on the Remote. **OR** Press **STOP/EJECT** (■/▲) on the VCR.

Pause playback and view still picture

Press **PAUSE** (||).

- Press **PLAY** (▶) to resume normal playback.

Pause and Frame-by-Frame playback

Press **PAUSE** (||) to pause, then press **▶▶|** (or **PAUSE** (||)) repeatedly.

- Press **PLAY** (▶) to resume normal playback.

Rewind/fast-forward

Press **REW** (◀◀) or **FF** (▶▶).

- Press **PLAY** (▶) to resume normal playback.
- If you press and hold **REW** (◀◀) or **FF** (▶▶) for more than 2 seconds, simply releasing it cancels the picture search, and normal playback resumes.

Rewind/fast-forward at variable speed (including slow-motion)

Press **◀◀** or **▶▶** repeatedly.

- Press **PLAY** (▶) to resume normal playback.
- Each time you press **◀◀** or **▶▶**, the playback speed changes. To decrease the speed during picture search, press the opposite direction button repeatedly.
- During still picture, press and hold **▶▶** to start forward slow motion playback. When you release the button, still picture resumes. During still picture, holding **PAUSE** (||) for more than 2 seconds also starts forward slow motion playback. If you press **PAUSE** (||) again, still picture resumes.

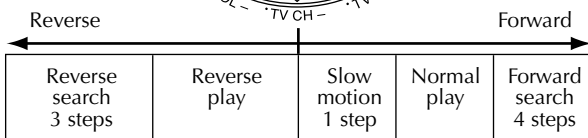
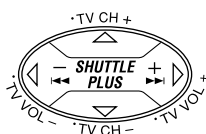

When the tape is not running

Rewind/fast-forward at high speed

Press **REW** (◀◀) or **FF** (▶▶).

Eject the tape

Press **STOP/EJECT** (■/▲).

- You can also eject the cassette when the VCR is turned off.

Turn off the VCR

Press **POWER**.

Playback Features

Adjusting tracking condition

— Tracking Adjustment

Automatic tracking adjustment

Whenever you insert a tape and start playback, automatic tracking starts working and continuously analyzes the signal to enable optimum picture quality during playback.

Manual tracking adjustment

If automatic tracking cannot eliminate noises well during playback, follow the procedures below.

- 1 Press **SP/EP** on the Remote during playback to activate manual tracking.
- 2 Press **CH +** and **-** to eliminate the noises. Press it briefly for a fine adjustment, or press and hold for a coarse adjustment.
- 3 Press **SP/EP** on the Remote again to reactivate automatic tracking.

Selecting monitor sound

— Audio Monitor

While playing back a tape on which stereo sound or SAP sound is recorded, press **A. MONITOR** on the Remote. Each time you press the button, sound changes.

HI-FI: Normally select this. Hi-Fi sound is played back.

HI-FI L: Sound on the left Hi-Fi channel is played back.

HI-FI R: Sound on the right Hi-Fi channel is played back.

NORM: Sound on the normal track is played back.

NORM HI-FI: Both sounds on the Hi-Fi track and normal track are mixed and played back.

NOTE:

The above indication appears when "SUPERIMPOSE" is set to "ON", though the monitor sound changes in sequence.

Automatic operations after rewinding

— Next Function Memory

The Next Function Memory "tells" the VCR what to do after rewinding is complete. Ensure that the VCR is in stop mode.

• For Automatic Playback Start

Press **REW** (◀◀), then press **PLAY** (▶) within 2 seconds.

• For Automatic Power Off

Press **REW** (◀◀), then press **POWER** within 2 seconds.

• For Automatic Timer Standby

Press **REW** (◀◀), then press **TIMER** within 2 seconds.

NOTE:

It is not possible to select the Automatic Timer Standby function if the cassette's record safety tab is removed.

Playing back tape repeatedly (100 times)

– Repeat Play

During playback, press and hold **PLAY** (▶) for more than 5 seconds. The play indicator (▷) on the display panel starts blinking slowly. To stop playback, press **STOP** (■) on the Remote or **STOP/EJECT** (■/▲) on the VCR.

Locating beginning of recordings

– Index Search

Index codes are placed on the tape at the beginning of each recording when recording on this VCR.

1 While the tape is not running, press **SHUTTLE PLUS** (◀◀) or ▶▶ on the Remote to start search.

2 To access a recording of 2 to 9 index codes away, press ◀◀ or ▶▶ repeatedly until the correct number is displayed on the screen (only if "SUPERIMPOSE" is set to "ON"). Playback begins automatically when the desired recording is located.

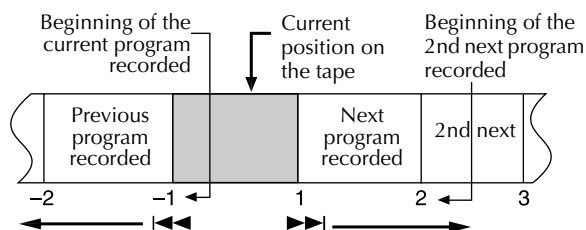

Locating beginning of timer recordings

– Instant Review

Press **REVIEW** on the Remote after ensuring that the VCR is turned off and that the timer mode is disengaged.

- The VCR turns on, and rewinds to the index code indicating the beginning of the last timer-recorded program, then begins playback automatically.
- You can access a program of 2 to 9 index codes away from the current position on the tape. If, for example, you have 5 programs recorded and you want to watch the third one, press **REVIEW** three times.
- The Instant Review function will also operate if the VCR is turned on.

Skipping unwanted portions

– Skip Search

Press **SKIP SEARCH** on the Remote once to 4 times during playback. Each press initiates a 30-second period of high speed playback (up to 2 minutes). When the specified portion of the tape is skipped, normal playback resumes automatically. To return to normal playback during Skip Search, press **PLAY** (▶).

Recording

It may be unlawful to record or play back copyrighted material without the consent of the copyright owner.

Accidental erasure prevention

To prevent accidental recording on a recorded cassette, remove its record safety tab. To record on it later, cover the hole with adhesive tape.

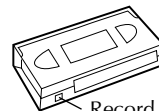

Basic Recording

1 Load a cassette

Make sure the record safety tab is intact. If not, cover the hole with adhesive tape before inserting the cassette.

- The VCR turns on, and the counter is reset, automatically.

2 Select recording channel

On the Remote

Press **CH+/-** or the **Number** keys.

On the VCR

Press **PAUSE[CH]**. The channel display on the display panel starts blinking. While the display is blinking, press **FF[CH+]** or **REW[CH-]** to select channel. After about 5 seconds, the channel display stops blinking.

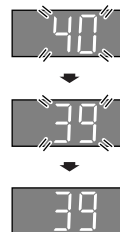

NOTES:

- You can select channel in the stop mode, recording pause mode or during rewind/fast-forward high-speed search.
- If no cassette is loaded, or during recording pause mode, you can select channel only by pressing **FF[CH+]** or **REW[CH-]**.
- If you connect the TV and the VCR only using the RF connection, press **TV/VCR** on the Remote so that the VCR mode indicator lights on the display panel, to view the program to be recorded.

3 Set tape speed

Press **SP/EP**.

4 Start recording

On the VCR, press **REC** (●). Or on the Remote, while holding **REC** (●), press **PLAY** (▶).

During recording

Pause recording

Press **PAUSE** (||).

- Press **PLAY** (▶) to resume recording.
- You can select channel in the recording pause mode.

Stop recording

Press **STOP** (■) on the Remote.

OR Press **STOP/EJECT** (■/▲) on the VCR.

Recording Features

Specifying recording length

— Instant Timer Recording (ITR)

During recording, press **REC** (●) on the VCR repeatedly until the recording length you want appears on the display panel. The record indicator (○) on the display panel starts blinking.

- Each time you press the button, recording length increases in 30-minute intervals (up to 6 hours).
- The VCR shuts off after recording is finished.
- To cancel an ITR, press **STOP** (■) on the Remote or **STOP/EJECT** (■/▲) on the VCR.

Watching one program while recording another

During recording...

- If you connect the TV and the VCR only using the RF connection to view pictures from the VCR, press **TV/VCR** on the Remote so that VCR mode indicator goes off from the display panel. (The TV broadcast being recorded disappears.)
- If you are using the AV connection to view pictures from the VCR, change the TV's input mode from AV to TV. Then, select the channel you want to watch, on the TV.

Second Audio Recording

This VCR's built-in MTS decoder enables reception of Multichannel TV Sound broadcast. To record a SAP program received, set "2ND AUDIO RECORD" to "ON".

Timer Recording

Up to 8 timer recording programs can be made using Express timer programming method as far as a year in advance. Remember, the clock must be set before you can program the timer.

NOTES:

- If all the 8 programs have already been set, "PROGRAM FULL" or "Full" appears on the TV screen or the display panel.
- After timer recording is completed, the VCR turns off automatically.
- You can program the timer recording while a regular recording is in progress; the menu screens will not be recorded.
- To timer-record cable or satellite channels, be sure to keep the cable box or DBS receiver turned on with the correct channel selected.
- Even if a power failure occurs, the VCR keeps your timer programs. However, the clock time, channel settings, and other menu settings are lost. As a result, when the power is supplied again to this VCR after the power failure, this VCR starts the Plug&Play setting automatically to restore the clock time and channel setting. If the clock time and channel setting are restored correctly, each timer program you have made will start at its start time unless its end time has elapsed.

Express Timer Programming

Load a cassette with the record safety tab intact. The VCR turns on, and the counter is reset, automatically.

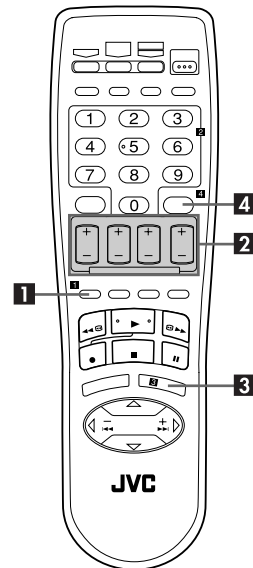

1 Press **PROG.** on the Remote to access the PlusCode No. screen.

2 Press **START+/−** once to access Program screen. Press **START+/−**, **STOP+/−**, **DATE+/−** or **CH+/−** repeatedly to enter the start time, stop time, date or channel.

- Press and hold **START+/−** or **STOP+/−** to increase the time in 30-minute intervals.
- To set the tape speed, press **SP/EP.**
- To timer-record daily (Monday–Friday) or weekly serials, press **DAILY (M-F)** or **WEEKLY.** Pressing the button again makes the "DAILY" or "WEEKLY" display disappear.

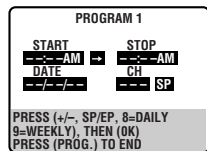

- Timer Recording -

- Press **OK** or **PROG.**.
 - If "PROGRAM NOT COMPLETED PROGRAM OVERLAP" appears, see "Program overlap warning display".
- Press **TIMER**. The VCR turns off automatically and "Ⓢ" is displayed on the display panel.

To use the VCR while it is in timer recording standby mode

Press **TIMER**, then press **POWER**. After you use the VCR, press **TIMER** again to put the VCR into timer recording standby mode.

Checking, canceling or changing program settings

1 Disengage timer

Press **TIMER**, then press **POWER**.

- When "AUTO TIMER" is set to "ON", you do not have to press **TIMER**.

2 Access Program Check screen

Press **PROG. CHECK**.

| PR | START | STOP | CH | DATE |
|----|--------|-------|-----|-------|
| 1 | 8:00P | 10:00 | 12 | 12/24 |
| 2 | 10:00A | 10:45 | 40 | 12/25 |
| 3 | 11:30P | 1:00 | 125 | 12/25 |
| 4 | | | | |
| 5 | | | | |
| 6 | | | | |
| 7 | | | | |
| 8 | | | | |

PRESS (CHECK) TO NEXT

3 Access Program screen

Press **PROG. CHECK** again. Each time you press **PROG. CHECK**, the next program's Program screen appears.

| PROGRAM 1 | | | |
|-----------|----------|----------|-------|
| START | STOP | DATE | CH |
| 8:00 PM | 10:00 PM | 12/24/00 | 12 SP |

PRESS (CANCEL) TO CANCEL
PRESS (CHECK) TO NEXT

4 Cancel or change program setting

To cancel a program, press **CANCEL** when the Program screen you do not want is shown.

To change a program, press the appropriate button: **START+/-**, **STOP+/-**, **DATE+/-**, **CH+/-**, and/or **SP/EP** when the Program screen on which you want to make changes is shown.

5 Return to normal screen

Press **PROG. CHECK** repeatedly until no Program screen is shown.

6 Reengage timer recording standby mode

Press **TIMER**. The VCR turns off automatically and "Ⓢ" is displayed on the display panel.

- When "AUTO TIMER" is set to "ON", the timer recording standby mode automatically resumes when you turn off the VCR.

Program overlap warning display

If "PROGRAM NOT COMPLETED PROGRAM OVERLAP" appears, you have another program overlapping the program you have just made. The Program Check screen appears and conflicting programs will start blinking.

| | | | | |
|-----------------------|--|--|--|--|
| PROGRAM NOT COMPLETED | | | | |
| PROGRAM OVERLAP | | | | |

➔

| PR | START | STOP | CH | DATE |
|----|--------|-------|-----|-------|
| 1 | 8:00P | 10:00 | 12 | 12/24 |
| 2 | 10:00A | 10:45 | 40 | 12/25 |
| 3 | 11:30P | 1:00 | 125 | 12/25 |
| 4 | 9:00P | 10:00 | 10 | 12/24 |
| 5 | | | | |
| 6 | | | | |
| 7 | | | | |
| 8 | | | | |

(▲▼), THEN (▶) (PROG.): END

Example:

Program 1 (you have just made) and Program 4 overlap each other

1 Select program to modify

Press $\Delta\nabla$, then press \triangleright .

- You can only select one of the overlapping programs.
- If you do not mind this overlap, press **PROG.** to finish the timer program setting. The program starting earlier or program with the lower program number will be recorded.

| PR | START | STOP | CH | DATE |
|----|--------|-------|-----|-------|
| 1 | 8:00P | 10:00 | 12 | 12/24 |
| 2 | 10:00A | 10:45 | 40 | 12/25 |
| 3 | 11:30P | 1:00 | 125 | 12/25 |
| 4 | 9:00P | 10:00 | 10 | 12/24 |
| 5 | | | | |
| 6 | | | | |
| 7 | | | | |
| 8 | | | | |

(▲▼), THEN (▶) (PROG.): END

2 Cancel or change program setting

To cancel a program, press **CANCEL** when the Program screen you do not want is shown.

To change a program, press the appropriate button: **START+/-**, **STOP+/-**, **DATE+/-**, **CH+/-**, and/or **SP/EP** when the Program screen on which you want to make changes is shown, then press **OK**.

- If the overlap is not yet solved, the conflicting programs will be shown on the Program check screen. Repeat the above steps again.

| PROGRAM 4 | | | |
|-----------|---------|----------|-------|
| START | STOP | DATE | CH |
| 9:00PM | 10:00PM | 12/24/00 | 10 SP |

PRESS (CANCEL) TO CANCEL
PRESS (OK) TO CONFIRM
PRESS (PROG.) TO END

Other Functions

Checking tape position

When you change the VCR operation mode from the stop mode to fast forward or rewind mode, or when you perform an Index Search or Instant Review, the tape position indicator appears.

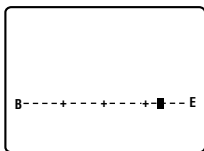

The position of "■" in relation to "B" (Beginning) or "E" (End) shows you where you are on the tape.

- Set "SUPERIMPOSE" to "ON".

Changing display information

Each time you press **DISPLAY**, the display panel shows the channel number and the clock time alternatively.



- You can change display in the stop, recording or recording pause mode, or during rewind/fast-forward high-speed search.
- When "SUPERIMPOSE" is set to "ON" and **DISPLAY** on the Remote is pressed, time counter will appear on the TV screen. To reset the time counter, press **C. RESET** on the Remote.

Timer warning display

A warning appears on the TV screen to tell you that the timer-recording is to start in 5 minutes if you are not in the timer recording standby mode at that time. Press **TIMER** to put the VCR into timer recording standby mode. To clear the display, press **CANCEL** on the Remote.



Function settings

You can use the other useful function settings on the Function Set screen.

1 Access Main Menu screen, then Function Set screen

Press **MENU** on the Remote. Press Δ/∇ to move the highlight bar (arrow) to "FUNCTION SET", then press **OK** or \triangleright .

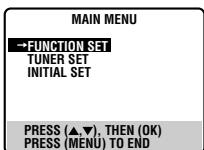

2 Select Function

Press Δ/∇ to move the highlight bar (arrow) to the function you want to set.

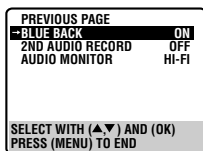
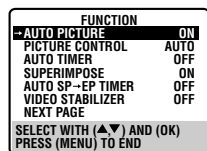

3 Change setting

Press **OK** or \triangleright . The default setting is **bold** in the following table. Press **MENU** to return to normal screen.

■ AUTO PICTURE — ON/OFF

When this function is set to "ON", this VCR checks the condition of the tape in use during playback, and compensates to provide the highest-possible playback pictures.

■ PICTURE CONTROL — AUTO(NORM)/EDIT/SOFT/SHARP

This function helps you to adjust the playback picture quality according to your preference.

AUTO (NORM): Normally select this. Picture quality is adjusted automatically. When "AUTO PICTURE" is "OFF", "NORM" will appear instead of "AUTO".

EDIT: Minimizes picture degradation during editing (recording and playback).

SOFT: Reduces image coarseness when viewing overlaid tapes containing much noise.

SHARP: Clearer, sharper-edged picture when viewing images with much flat, same-colored surfaces such as cartoons.

NOTE:

Select "EDIT" when you are editing tapes. After you finish editing the tapes, select "AUTO".

■ AUTO TIMER — ON/OFF

• When this function is set to "ON":

The timer recording standby mode is automatically engaged when the VCR is turned off. It is temporarily canceled when the VCR is turned on. You do not have to press **TIMER** to engage or disengage the timer recording standby mode.

• When this function is set to "OFF":

You have to press **TIMER** to engage or disengage the timer recording standby mode.

■ SUPERIMPOSE — ON/OFF

When this function is set to "ON", various VCR status information (on-screen display) appears on the screen.

NOTE:

When you use this VCR as the playback VCR for editing a tape, be sure to set this function to "OFF"; otherwise, the VCR status information (on-screen display) will be recorded on the edited tape.

■ AUTO SP→EP TIMER — ON/OFF

When this function is set to "ON", the VCR automatically switches to EP mode to allow complete recording if there is not enough tape to record the entire program while timer-recording in SP mode.

For Example, Recording a program of 140 minutes in length onto a 120-minute tape

Approximately 110 minutes Approximately 30 minutes

| | |
|---------|---------|
| SP mode | EP mode |
|---------|---------|

NOTES:

- If you have programmed the VCR to timer-record 2 or more programs, do not use this function, but change the tape speed manually during timer programming.
- There may be some noise and sound disturbance where the tape speed switches from SP to EP mode on the tape.
- This function is not available during ITR (Instant Timer Recording), and will not work properly on the following tapes: T(ST)-30, T(ST)-60, T(ST)-90, and T(ST)-120.

■ VIDEO STABILIZER — ON/OFF

When this function is set to “ON”, you can automatically correct vertical vibrations in the picture when playing back unstable recordings made on another VCR.

NOTE:

To watch recordings with close-caption or when you finish viewing a tape, set this function to “OFF”.

■ BLUE BACK — ON/OFF

When this function is set to “ON”, the TV screen becomes all blue in the following cases:

- When receiving a channel not in use.
- When stopping playback.

NOTE:

When you want to receive an unstable channel with poor signals, set this function to “OFF”.

■ 2ND AUDIO RECORD — ON/OFF

- When this function is set to “ON”;

If a SAP program is received, the SAP audio is recorded on both the normal and Hi-Fi tracks. The main audio is not recorded.

If a non-SAP program is received, the main audio is recorded on both the Hi-Fi and normal tracks.

- When this function is set to “OFF”, the SAP audio cannot be recorded.

NOTES:

When the channel is changed on the VCR;

- The “STEREO” indication appears on the screen for about 5 seconds if the program is a stereo broadcast.
- The “SAP” indication appears on the screen for about 5 seconds if the program is a SAP broadcast.
- Both indications appear when a stereo program is accompanied by SAP sound.

■ AUDIO MONITOR — HI-FI/HI-FI L/HI-FI R/NORM/MIX

This VCR can record two sound tracks simultaneously (normal and Hi-Fi) on a Hi-Fi stereo tape. You can select the sound track(s) to listen to while playing back a Hi-Fi stereo tape. In addition, when playing back a prerecorded tape containing two separate audio programs on the Hi-Fi tracks, you can choose either one by selecting either “HI-FI L” or “HI-FI R”.

HI-FI: Normally select this. Hi-Fi sound is played back.

HI-FI L: Sound on the left Hi-Fi channel is played back.

HI-FI R: Sound on the right Hi-Fi channel is played back.

NORM: Sound on the normal track is played back.

MIX: Both sounds on the Hi-Fi track and normal track are mixed and played back.

NOTES:

- While playing back a monaural tape, sounds on the normal track will be heard regardless of this setting.
- If RF connection is used for viewing pictures on the TV, sound will be monaural even though you select “HI-FI”.
- You can also use the **A. MONITOR** button on the Remote to select the desired monitor sound.

Multi-Brand Remote Control

This Remote can control some functions of remote controllable TVs, cable boxes or DBS (Direct Broadcast Satellite) receivers listed below. Without setting, you can control a JVC TV.

NOTES:

- Some unit's brands have more than one code. If the unit does not function with a specified code, try other codes.
- Depending on the type of unit, some or all functions cannot be operated using this Remote.
- It's not possible to operate a unit not equipped with a remote sensor.
- It's not possible to set the Remote for both your cable box and a DBS receiver at the same time.
- Once you have set the Remote to operate the unit, you do not have to set it until you replace the batteries from the Remote.

TV Brand Setting

1 Turn on TV

Turn on the TV using the Power button on the TV or its Remote.

2 Set TV brand code

- 1 Press and hold **TV**.
- 2 Press **MBR SET**.
- 3 Press the **Number keys** to enter your TV's brand code.
- 4 Press **OK**, and release **TV**. The TV should turn off.

3 Operate TV

While holding down **TV**, press one of the following buttons: **POWER**, **TV/VCR**, **TV CH+/-**, **TV Muting** (TV Muting), **TV VOL+/-**, and the **Number keys**.

- For some brands, you must press **ENTER** after having pressed the **Number keys** to enter a channel number.

| TV BRAND | CODE | TV BRAND | CODE |
|------------|--------|----------|------|
| JVC | 01, 03 | SONY | 07 |
| HITACHI | 10 | SAMSUNG | 12 |
| MAGNAVOX | 02 | SANYO | 13 |
| mitsubishi | 03 | SEARS | 13 |
| PANASONIC | 04, 11 | TOSHIBA | 08 |
| RCA | 05 | ZENITH | 09 |
| SHARP | 06 | | |

Cable Box or DBS Receiver Brand Setting

1 Turn on cable box or DBS receiver

Turn on the cable box or DBS receiver using the Power button on the unit or its Remote.

2 Enter brand code

- 1 Press and hold **CABLE/DBS**.
- 2 Press **MBR SET**.
- 3 Press the **Number keys** to enter your cable box's (or DBS receiver's) brand code.
- 4 Press **OK**, and release **CABLE/DBS**.

3 Operate cable box or DBS receiver

While holding down **CABLE/DBS**, press one of the following buttons: **POWER**, **TV CH+/-**, and the **Number keys**.

- For some brands, you must press **ENTER** after having pressed the **Number keys** to enter a channel number.
- To change the cable box's (or DBS receiver's) channels, press **TV CH+/-** or the **Number keys**. (The **CH+/-** button can be used to change the VCR's channels only.)

| CABLE BOX BRAND | CODE |
|---------------------|----------------------------|
| ARCHER | 01, 05, 17 |
| CABLETENNA | 01, 17 |
| CABLEVIEW | 15, 16, 17, 21, 25 |
| CITIZEN | 15, 16, 17, 21, 25 |
| CURTIS | 02 |
| DIAMOND | 01, 17 |
| EASTERN | 19 |
| GC BRAND | 15, 16, 17, 21, 25 |
| GEMINI | 15 |
| GENERAL INSTRUMENTS | 01, 04, 06, 11, 12, 15, 28 |
| HAMLIN | 10, 18, 19, 23 |
| JASCO | 15 |
| JERROLD | 01, 04, 06, 11, 12, 15, 28 |
| NOVAVISION | 02 |
| OAK | 07 |
| PANASONIC | 13, 14 |
| PULSER | 15, 16, 17, 21, 25 |
| RCA | 13, 14 |
| REGAL | 10, 18, 19, 23 |
| REGENCY | 19 |
| REMBRANDT | 01, 16, 17 |
| SAMSUNG | 05, 16, 24 |
| SCIENTIFIC ATLANTA | 02 |
| SIGMA | 07 |
| SL MARX | 05, 16, 17, 24, 25 |
| SPRUCER | 13, 14 |
| STARGATE | 05, 15, 16, 17, 21, 24, 25 |
| TELEVIEW | 05, 16, 24 |
| TOCOM | 01, 04, 16 |
| UNIKA | 01, 17 |
| UNIVERSAL | 16, 17, 25 |
| VIDEOWAY | 03, 09, 22 |
| ZENITH | 03, 09, 22 |

| DBS RECEIVER BRAND | CODE |
|-------------------------|------|
| JVC (DISH Network) | 51 |
| ECHOSTAR (DISH Network) | 51 |
| PRIMESTAR | 50 |
| SONY (DSS) | 41 |
| RCA (DSS) | 40 |

Changing Remote Control Code

This Remote is capable of transmitting two control codes; one set to respond to A code control signals and another set to respond to B code control signals. This Remote control is preset to send A code signals because your VCR is initially set to respond to A code signals. You can easily modify your VCR and the Remote to respond to B code signals. When using two JVC VCRs, set two VCRs and their Remotes to different codes, so that you can operate these VCRs separately.

1 Set remote control code for Remote

- 1 Press and hold **A/B**.
- 2 Press the **Number key "2"**.
- 3 Press **OK**, and release **A/B**.

- The Remote now can transmit B code control signals.

2 Check remote control code for VCR

Press and hold **▶** on the VCR for more than 5 seconds while the VCR is turned off. The code currently set appears on the display panel.

3 Change code for VCR

Press any key on the Remote. The VCR now responds to B code control signals.

- To set the Remote and the VCR back to A code control signals, repeat the same procedure as shown above except pressing the **Number key "1"** in step 2 of 1.

To control two VCRs with the same Remote

You can control two JVC VCRs by switching the remote control code for the Remote between A and B (step 1), keeping two VCRs to different control codes.

- To change only the remote control code for the Remote, DO NOT perform steps 2 and 3.

Editing

You can use your VCR as the playback or recording VCR. You can use a camcorder as the playback VCR and your VCR as the recording VCR. Refer also to the other components' instruction manuals for connection and its operations.

1 Make connections

Example: When using this VCR as the playback VCR

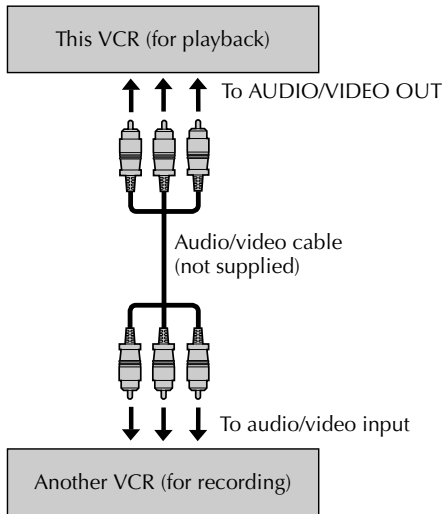

- When using this VCR as the recording VCR, connect this VCR's audio/video input connectors to the audio/video output connectors on the other VCR. If the playback VCR is monaural, connect the audio output connector on the playback VCR to the left audio input connector on this VCR.

2 Load cassettes

Insert the playback cassette into the playback VCR and the cassette to be recorded on into the recording VCR.

3 Select input mode on recording VCR

Select the correct external input on the recording VCR. On this VCR (when using this VCR as the recording VCR); Select "F-1" — when connecting the other VCR to the audio/video input connectors on the front panel. Press **AUX** or **CH+/-** on the Remote. You can select the input mode also by pressing **PAUSE[CH]**, and then **FF[CH+]** or **REW[CH-]** on the VCR. See step 2 in "Basic Recording".

4 Select edit mode

Set the edit mode to "ON" for the VCRs if such a mode is equipped.

- On this VCR, set "PICTURE CONTROL" to "EDIT".

5 Start playback

Press **PLAY** (▶) on the playback VCR.

6 Start recording

Press **REC** (●) on the recording VCR.

Specifications

GENERAL

| | |
|------------------------|---|
| Power requirement | : AC 120 V~, 60 Hz |
| Power consumption | |
| Power on | : 18 W |
| Power off | : 2.0 W |
| Temperature | |
| Operating | : 5°C to 40°C (41°F to 104°F) |
| Storage | : -20°C to 60°C (-4°F to 140°F) |
| Operating position | : Horizontal only |
| Dimensions (W x H x D) | : 360 mm x 94 mm x 247 mm (14-3/16" x 3-3/4" x 9-3/4") |
| Weight | : 3.0 kg (6.6 lbs) |
| Format | : VHS NTSC standard |
| Maximum recording time | |
| SP | : 210 min. with ST-210 video cassette |
| EP | : 630 min. with ST-210 video cassette |

VIDEO/AUDIO

| | |
|---------------------------|---|
| Signal system | : NTSC-type color signal and EIA monochrome signal, 525 lines/60 fields |
| Recording/Playback system | : DA-4 (Double Azimuth) head helical scan system |
| Signal-to-noise ratio | : 45 dB |
| Horizontal resolution | : 230 lines |
| Frequency range | |
| Normal audio | : 70 Hz to 10,000 Hz |
| Hi-Fi audio | : 20 Hz to 20,000 Hz |
| Input/Output | : RCA connectors (IN x 1, OUT x 1) |

TUNER

| | |
|------------------|---|
| Tuning system | : Frequency-synthesized tuner |
| Channel coverage | |
| VHF | : Channels 2-13 |
| UHF | : Channels 14-69 |
| CATV | : 113 Channels |
| RF output | : Channel 3 or 4 (switchable; preset to Channel 3 when shipped) 75 ohms, unbalanced |

TIMER

| | |
|---|--|
| Clock reference | : Quartz |
| Program capacity | : 1-year programmable timer/ 8 programs |
| Memory backup for timer is not supported. | |

ACCESSORIES

| | |
|----------------------|---|
| Provided accessories | : RF cable (F-type), Infrared remote control unit, "AA" battery x 2 |
|----------------------|---|

Specifications shown are for SP mode unless specified otherwise. E. & O.E. Design and specifications subject to change without notice.

FOR SERVICING (Only in U.S.A.)

HOW TO LOCATE YOUR JVC SERVICE CENTER

TOLL FREE: 1-800-537-5722

<http://www.jvc.com>

Dear Customer,

In order to receive the most satisfaction from your purchase, please read the instruction booklet before operating the unit. In the event that repair is necessary, or for the address nearest your location within the Continental United States, please call 1-800-537-5722 for your nearest authorized servicer or visit our website at www.JVC.com. Remember to retain your Bill of Sale for Warranty Service.

— JVC

JVC SERVICE & ENGINEERING COMPANY OF AMERICA

DIVISION OF JVC AMERICAS CORP.

Sophisticated electronic products may require occasional service. Just as quality is a keyword in the engineering and production of the wide array of JVC products, service is the key to maintaining the high level performance for which JVC is world famous. The JVC service and engineering organization stands behind our products.

NATIONAL HEADQUARTERS
JVC SERVICE & ENGINEERING COMPANY OF AMERICA
DIVISION OF JVC AMERICAS CORP.
10 New Maple Avenue
Pine Brook, NJ 07058-9641

ACCESSORIES

*To purchase accessories for your JVC product, you may contact your local JVC Dealer.
From the 48 Continental United States call toll free:
1-800-882-2345 or on the web at www.JVC.com*

Don't service the product yourself.

CAUTION

*To prevent electrical shock, do not open the cabinet.
There are no user serviceable parts inside.
Please refer to qualified service personnel for repairs.*

WARRANTY (Only in U.S.A.)

LIMITED WARRANTY

CONSUMER VIDEO 1-90

JVC COMPANY OF AMERICA warrants this product and all parts thereof, except as set forth below ONLY TO THE ORIGINAL PURCHASER AT RETAIL to be FREE FROM DEFECTIVE MATERIALS AND WORKMANSHIP from the date of original retail purchase for the period as shown below. ("The Warranty Period")

| | |
|-------|---------|
| PARTS | LABOR |
| 1 YR | 90 DAYS |

THIS LIMITED WARRANTY IS VALID ONLY IN THE FIFTY (50) UNITED STATES, THE DISTRICT OF COLUMBIA AND IN COMMONWEALTH OF PUERTO RICO.

WHAT WE WILL DO:

If this product is found to be defective, JVC will repair or replace defective parts at no charge to the original owner. Such repair and replacement services shall be rendered by JVC during normal business hours at JVC authorized service centers. Parts used for replacement are warranted only for the remainder of the Warranty Period. All products and parts thereof may be brought to a JVC authorized service center on a carry-in basis except for Television sets having a screen size 25 inches and above which are covered on an in-home basis.

WHAT YOU MUST DO FOR WARRANTY SERVICE:

Return your product to a JVC authorized service center with a copy of your bill of sale. For your nearest JVC authorized service center, please call toll free: (800) 537-5722.

If service is not available locally, box the product carefully, preferably in the original carton, and ship, insured, with a copy of your bill of sale plus a letter of explanation of the problem to the nearest JVC Factory Service Center, the name and location of which will be given to you by the toll-free number.

If you have any questions concerning your JVC Product, please contact our Customer Relations Department.

WHAT IS NOT COVERED:

This limited warranty provided by JVC does not cover:

1. Products which have been subject to abuse, accident, alteration, modification, tampering, negligence, misuse, faulty installation, lack of reasonable care, or if repaired or serviced by anyone other than a service facility authorized by JVC to render such service, or if affixed to any attachment not provided with the products, or if the model or serial number has been altered, tampered with, defaced or removed;
2. Initial installation and installation and removal for repair;
3. Operational adjustments covered in the Owner's Manual, normal maintenance, video and audio head cleaning;
4. Damage that occurs in shipment, due to act of God, and cosmetic damage;
5. Signal reception problems and failures due to line power surge;
6. Video Pick-up Tubes/CCD Image Sensor, Cartridge, Stylus (Needle) are covered for 90 days from the date of purchase;
7. Accessories;
8. Batteries (except that Rechargeable Batteries are covered for 90 days from the date of purchase);

There are no other express warranties except as listed above.

THE DURATION OF ANY IMPLIED WARRANTIES INCLUDING THE IMPLIED WARRANTY OF MERCHANTABILITY, IS LIMITED TO THE DURATION OF THE EXPRESS WARRANTY HEREIN.

JVC SHALL NOT BE LIABLE FOR THE LOSS OF USE OF THE PRODUCT, INCONVENIENCE, LOSS OR ANY OTHER DAMAGES, WHETHER DIRECT, INCIDENTAL OR CONSEQUENTIAL (INCLUDING, WITHOUT LIMITATION, DAMAGE TO TAPES, RECORDS OR DISCS) RESULTING FROM THE USE OF THIS PRODUCT, OR ARISING OUT OF ANY BREACH OF THIS WARRANTY. ALL EXPRESS AND IMPLIED WARRANTIES, INCLUDING THE WARRANTIES OF MERCHANTABILITY AND FITNESS FOR PARTICULAR PURPOSE, ARE LIMITED TO THE WARRANTY PERIOD SET FORTH ABOVE.

Some states do not allow the exclusion of incidental or consequential damages or limitations on how long an implied warranty lasts, so these limitations or exclusions may not apply to you. This warranty gives you specific legal rights and you may also have other rights which vary from state to state.

JVC COMPANY OF AMERICA
DIVISION OF JVC AMERICAS CORP.

1700 Valley Road
Wayne, New Jersey 07470

REFURBISHED PRODUCTS CARRY A SEPARATE WARRANTY, THIS WARRANTY DOES NOT APPLY. FOR DETAILS OF REFURBISHED PRODUCT WARRANTY, PLEASE REFER TO THE REFURBISHED PRODUCT WARRANTY INFORMATION PACKAGED WITH EACH REFURBISHED PRODUCT.

For customer use:

Enter below the Model No. and Serial No. which is located either on the rear, bottom or side of the cabinet. Retain this information for future reference.

Model No.: _____

Serial No.: _____

Purchase date: _____

Name of dealer: _____